

GL5.34 (B50EM) - GL7.40 (C50EM) - PASSPORT 50.32 (A50)

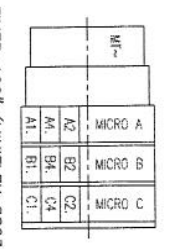

TIMER 120" (CROUZET 600 621/5261).

TIMER 120" (MINIFLEX 8803).

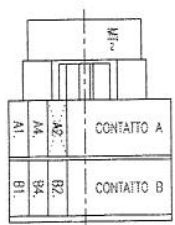
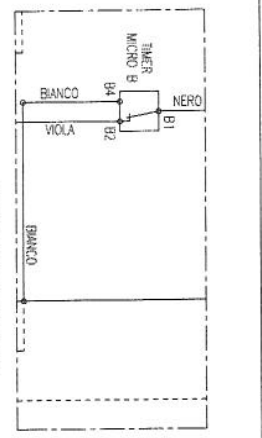
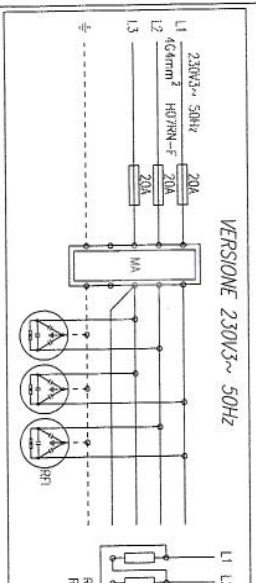
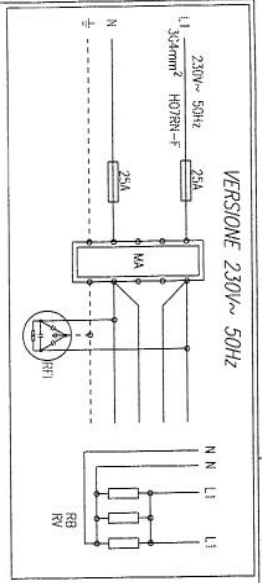
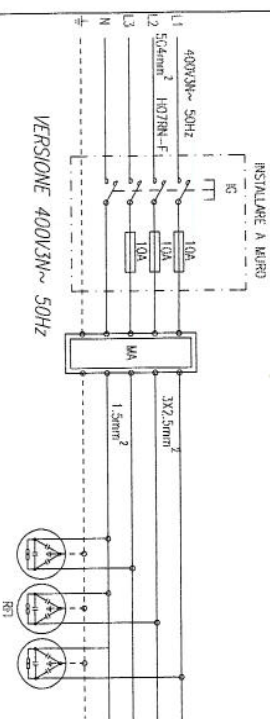

SEZIONE E ISOLANTE CONDUTTORE:
 GL7.40EM (C50EM) 1.5-2.5mm² CONMA-SIL
 RIMANENTI CONDUTTORI = 0.75mm² CONMA-SIL.

GL5.34EM (B50EM)
 GL7.40EM (C50EM)
 AP 50.32 (PASSPORT 50.32)

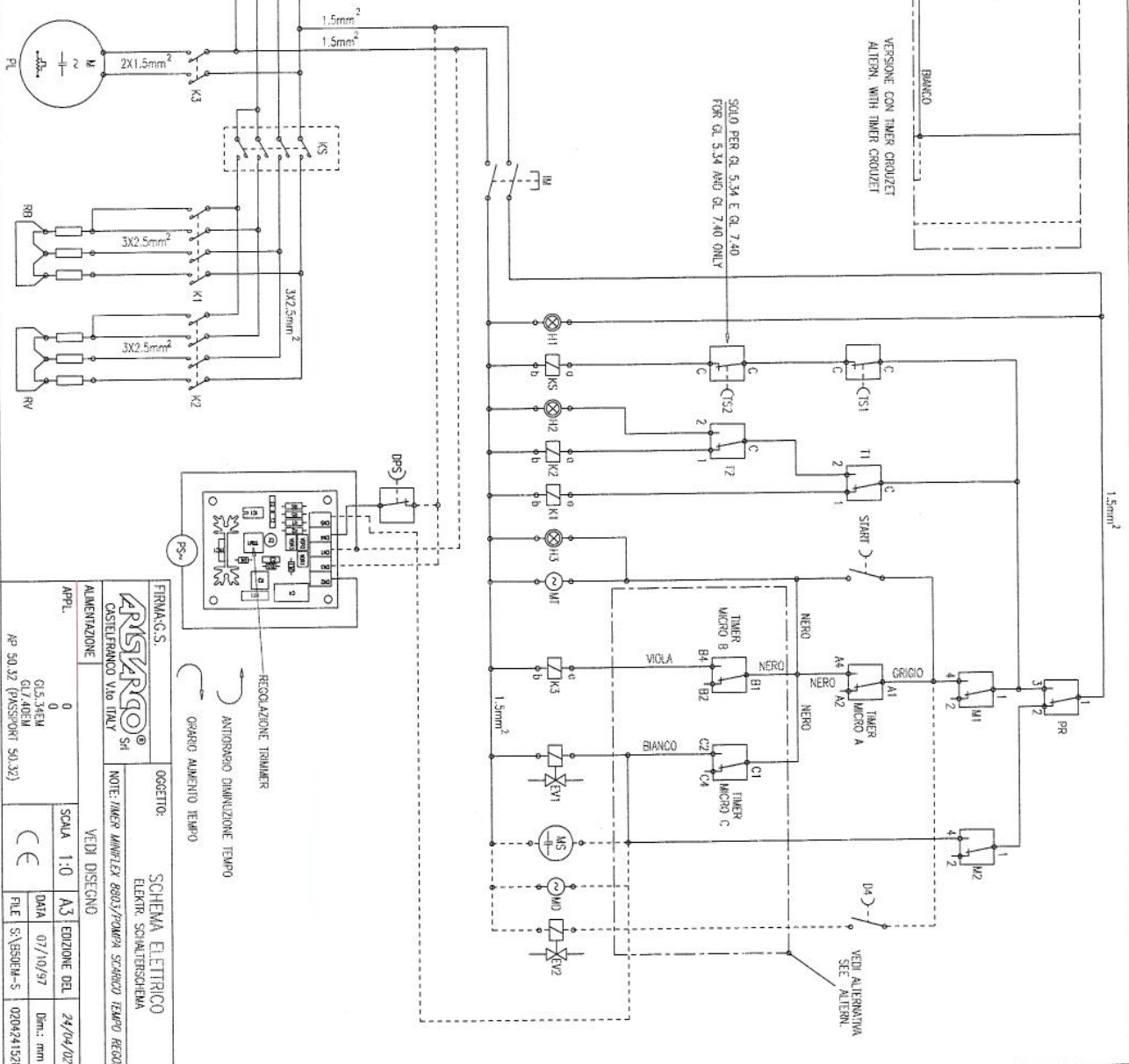

FIRMAG. S.		ARSTARCO®		OCCHETTO:		SCHEMA ELETTRICO	
COSTRUTTORE		ARSTARCO S.p.A.		NOTE: TIMER MINIFLEX 8803/FORMA STANDARD TEMPO REGOL.		ELETTR. SCHALTZEICHEN	
ALIMENTAZIONE		0		VEDEI DISEGNO		SCALA 1:0	
APPL.		GL5.34EM		VEDI DISEGNO		EDIZIONE DEL	
		GL7.40EM		VEDI DISEGNO		DATA	
		AP 50.32 (PASSPORT 50.32)		VEDI DISEGNO		FILE	
				VEDI DISEGNO		Dm.: mm	
				VEDI DISEGNO		0204241570	

REGOLAZIONE TEMPO
 ANTISURTO SMANIZZAZIONE TEMPO
 OPZIOE ALIMENTAZIONE TEMPO